

Tefal®

STEAMER AQUATIMER

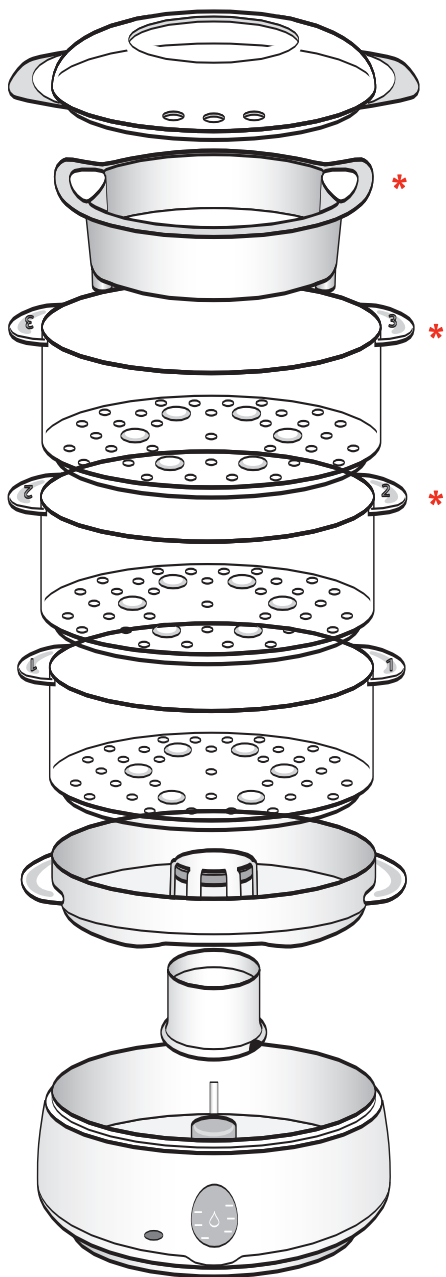

www.tefal.com



* selon modèle • je nach Modell • afhankelijk van het model

1

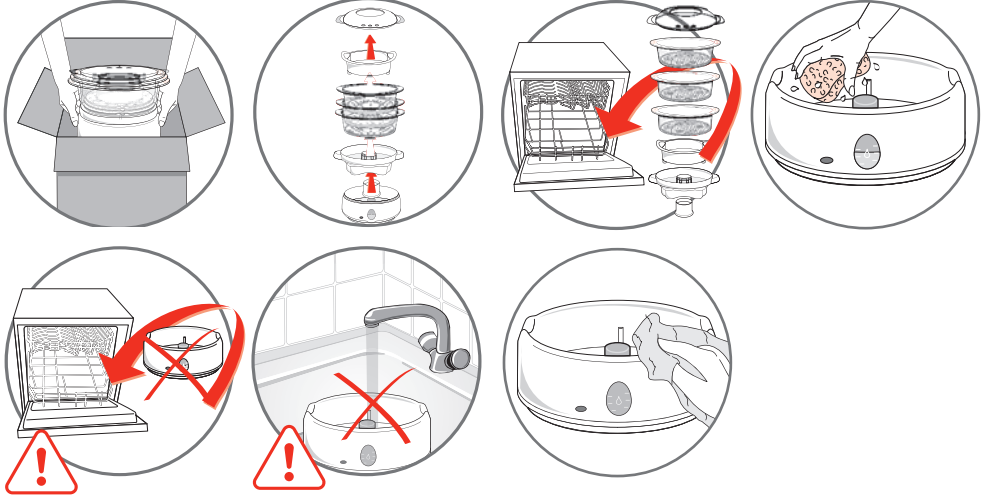

2

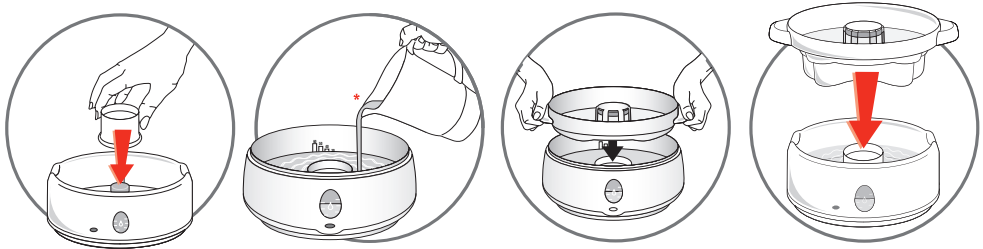



3

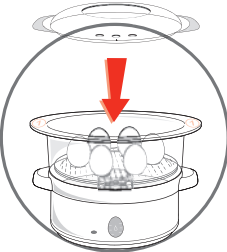
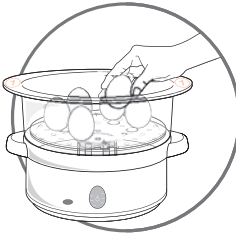
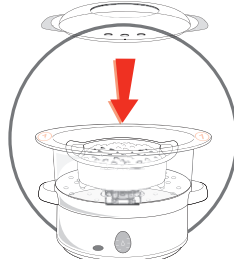
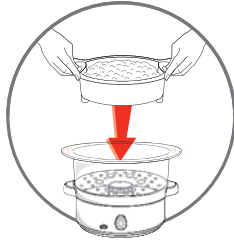
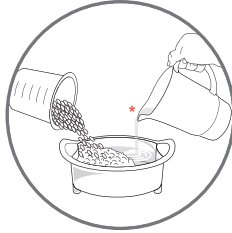
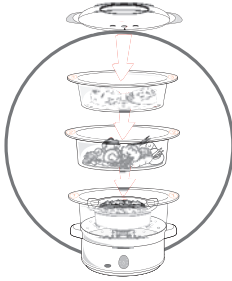

* eau • wasser • water

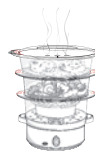

4

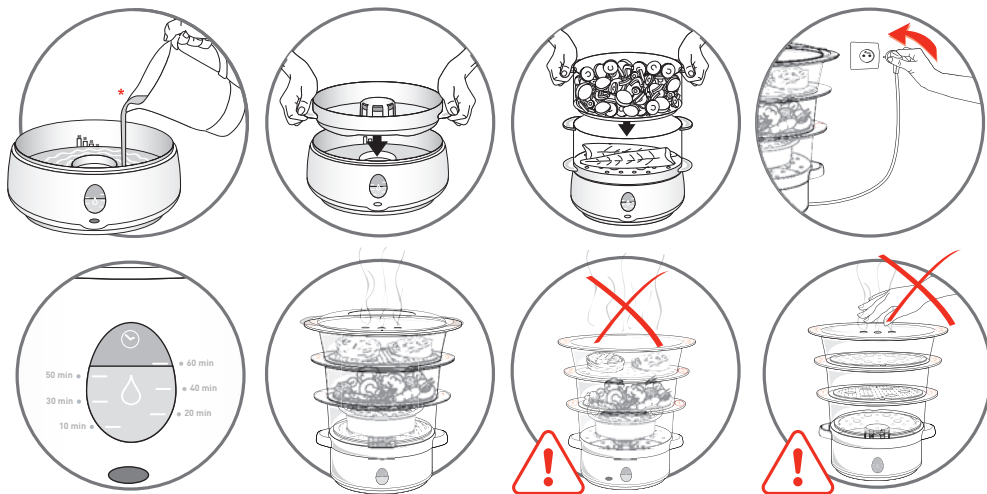





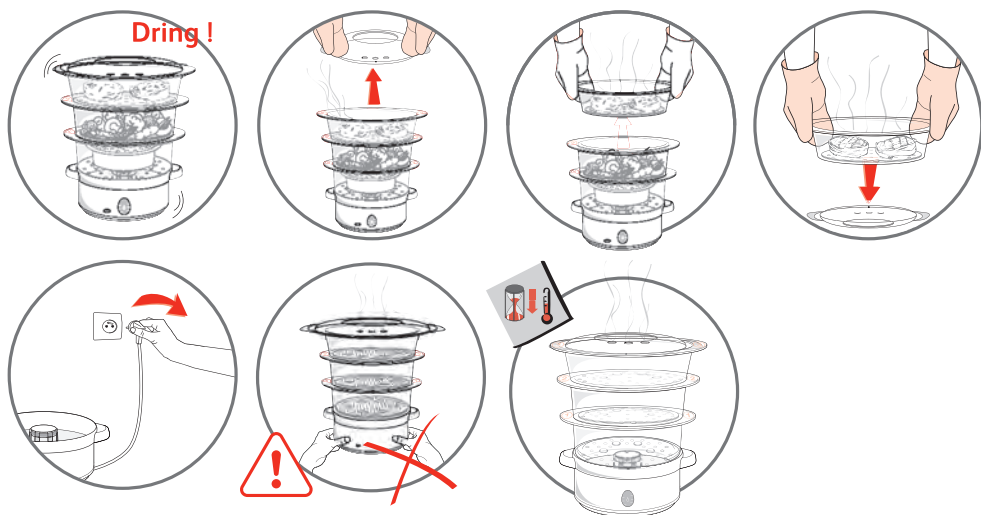

















* eau • wasser • water

5





		
	450 g	8 - 10 min
	450 g	11 - 16 min
	450 g	16 - 21 min
	600 g	27 - 32 min
	1 kg	16 - 21 min
	200 g	3 - 7 min
	100 g	6 - 10 min
	450 g	21 - 26 min
	4	32 - 37 min
	600 g	21 - 26 min
	700 g	30 - 40 min
	500 g	11 - 16 min
	10 g	10 - 15 min
	6	18 - 20 min
	3	32 - 37 min
	400 g	16 - 21 min
	400 g	21 - 26 min
	500 g	11 - 16 min
	600 g	16 - 19 min
	300 g	11 - 13 min
	300 g	16 - 21 min
	500 g	16 - 21 min

		
	500 g	21 - 26 min
	300 g	20 - 22 min
	500 g	16 - 21 min
	500 g	12 - 15 min
	400 g	21 - 26 min
	400 g	21 - 26 min
	600 g	43 - 48 min
	600 g	16 - 21 min
	1	27 - 32 min
	300 g	11 - 16 min
	400 g	11 - 16 min
	200 g	25 min
	200 g	21 - 26 min
	150 g	27 - 35 min
	150 g	16 - 18 min
	4	11 - 16 min
	4	21 - 26 min
	450 g	16 - 21 min
	4	11 - 16 min

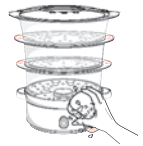

7

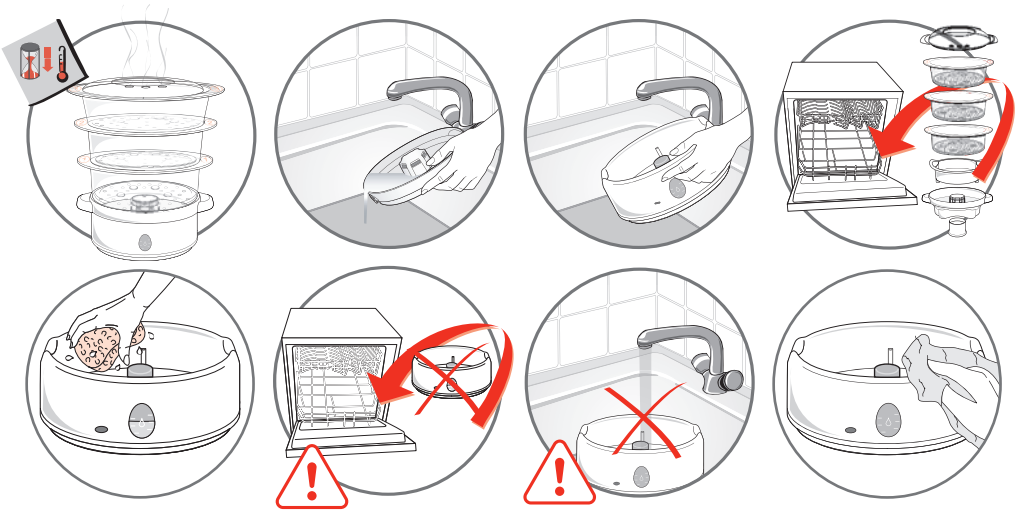

8

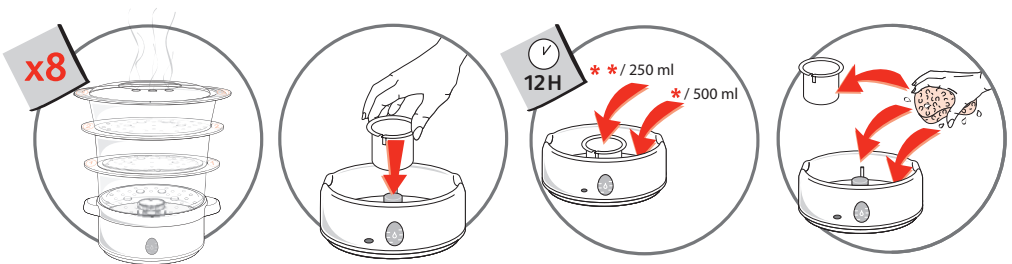

* eau • wasser • water •

** vinaigre • veggig • azijn

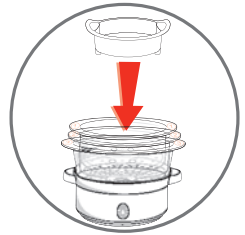
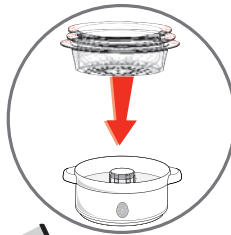
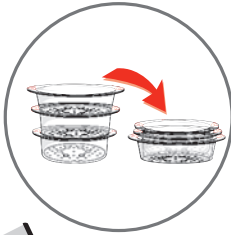
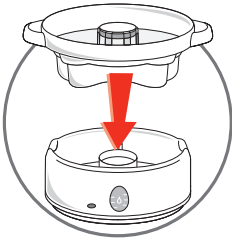
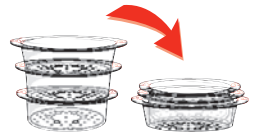

OK



NO

