

# FILTRA PRO





**3L**

**4L**

**3L**

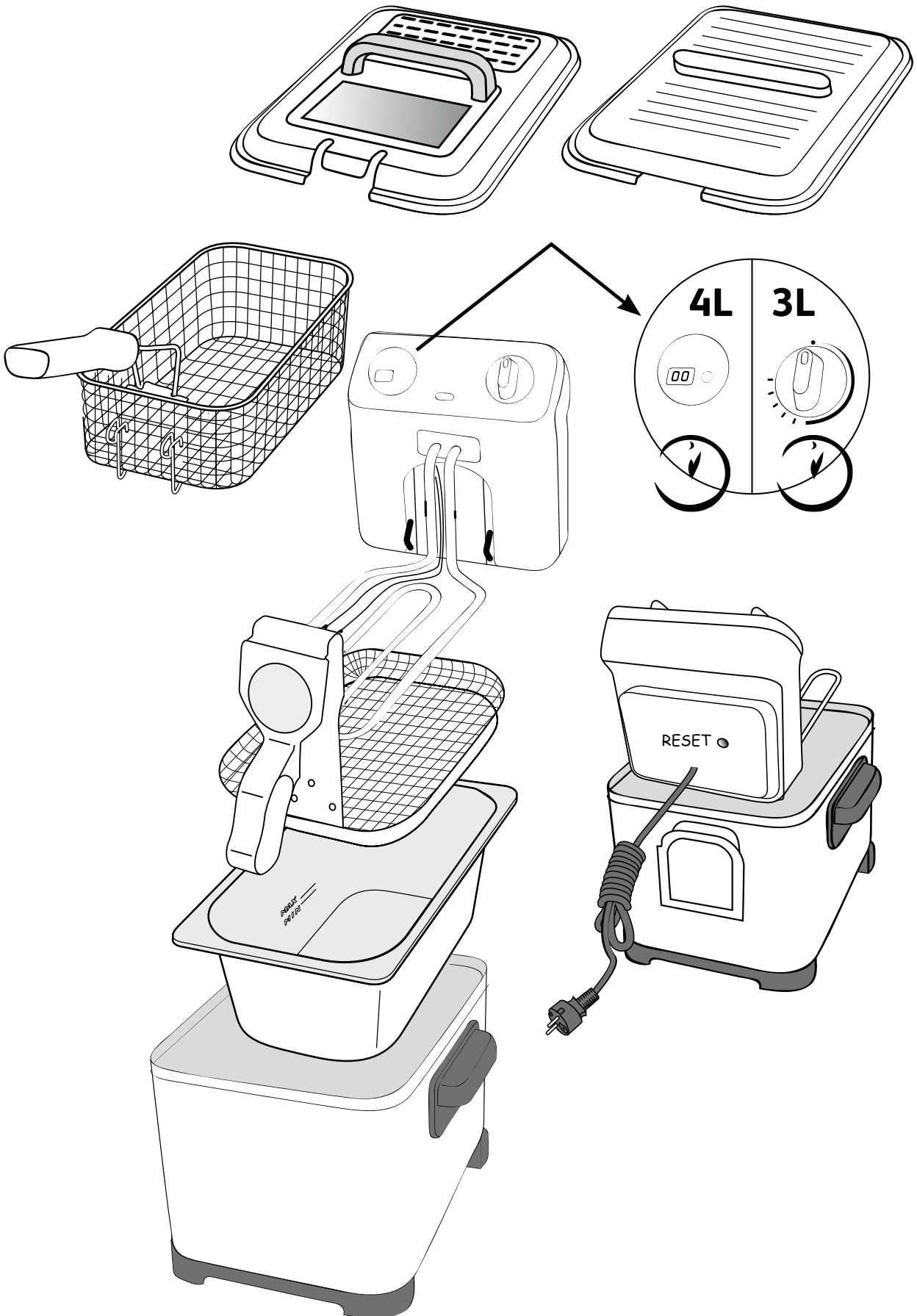



1

---

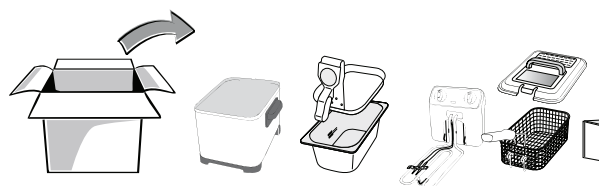
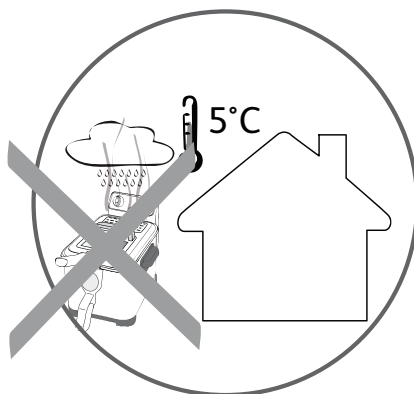
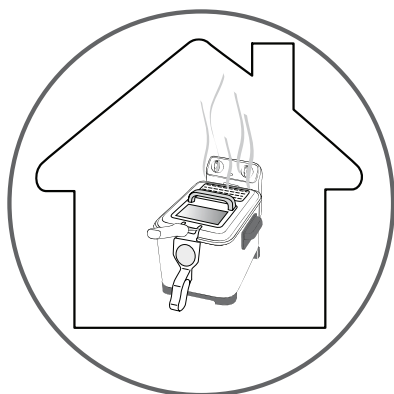

2

---

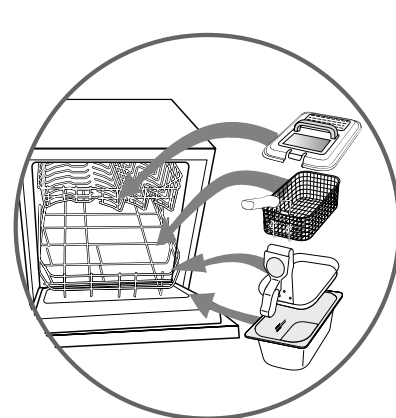
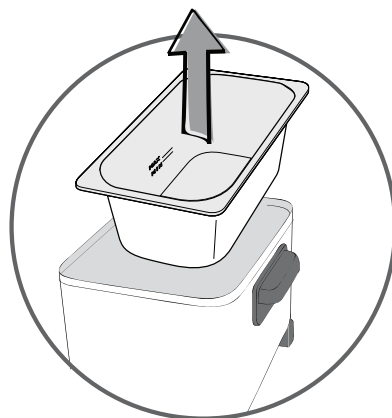
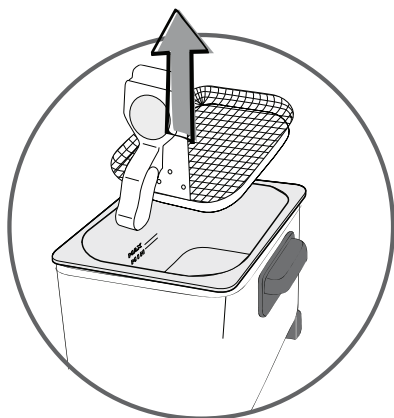
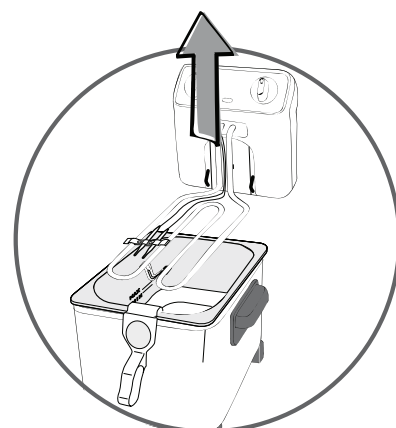
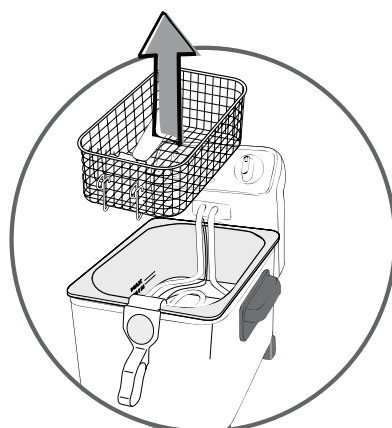
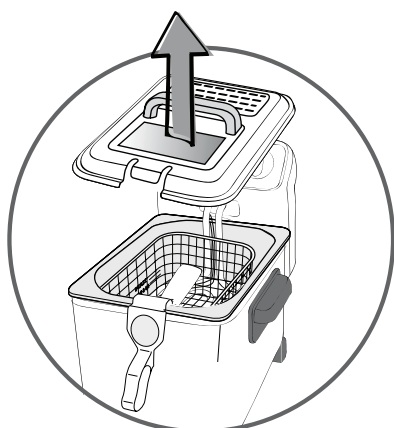

4

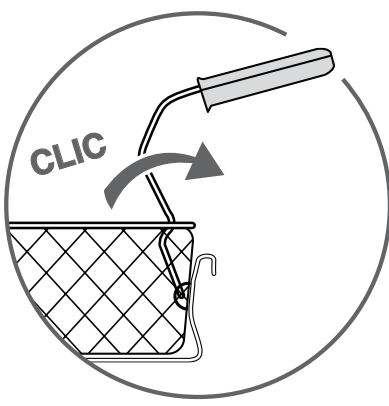
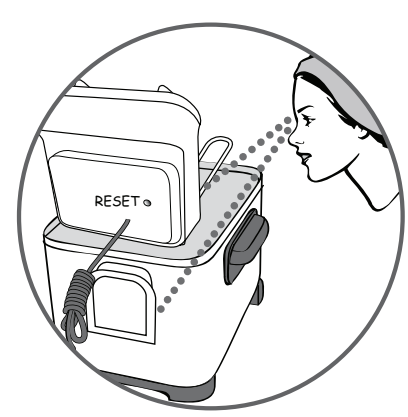
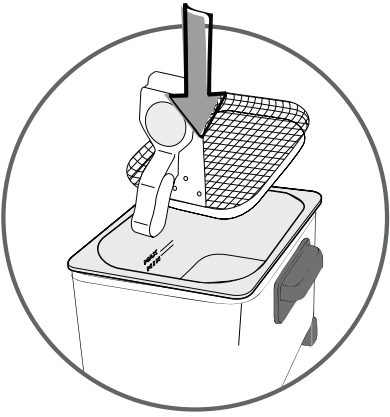
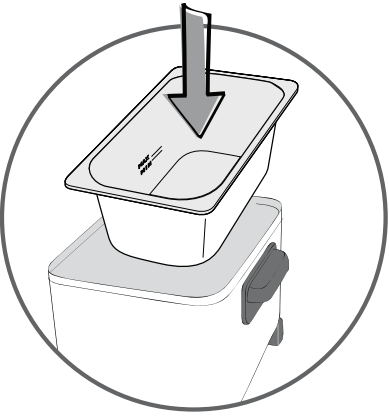
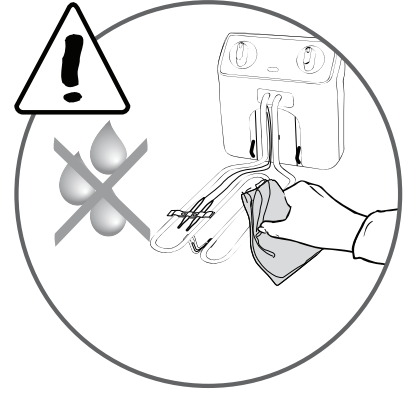
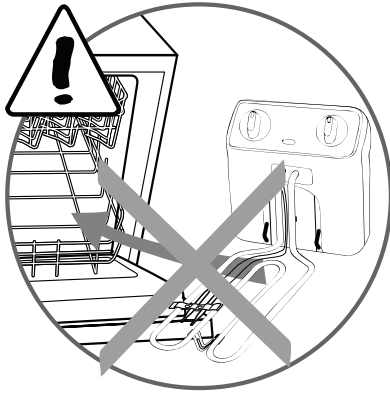
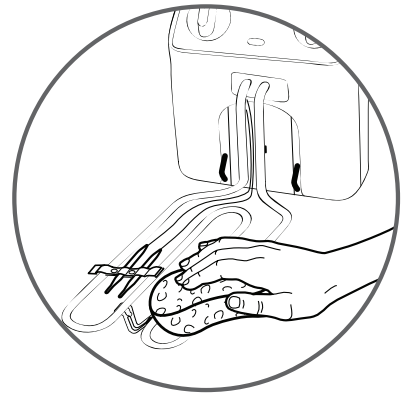
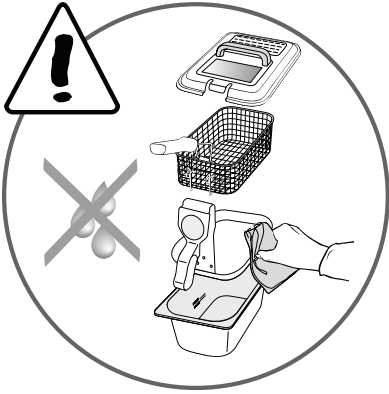



Model	3L	4L
Min.	2,2L	3,3L
Max.	3L	4L

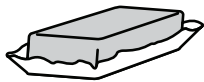
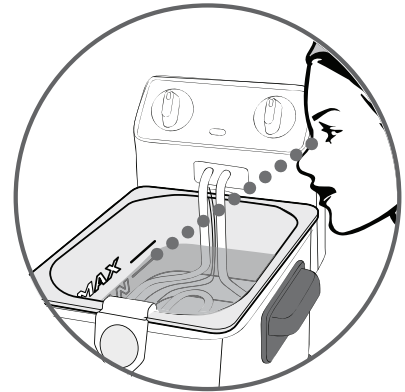

Model	3L	4L
Min.	1925 g	2890 g
Max.	2625 g	3500 g

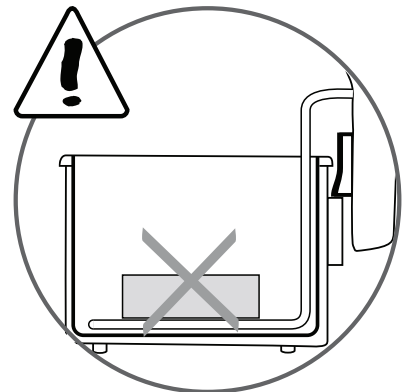
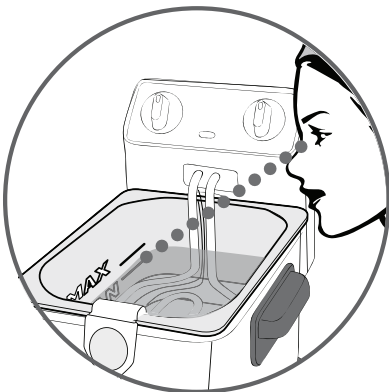
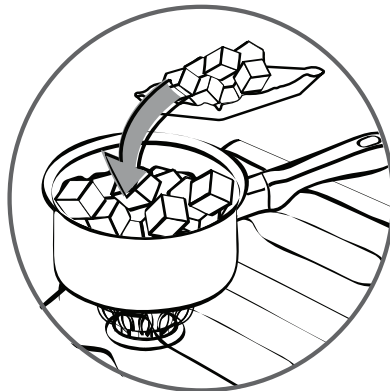

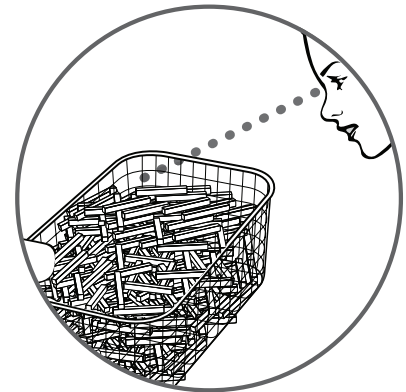
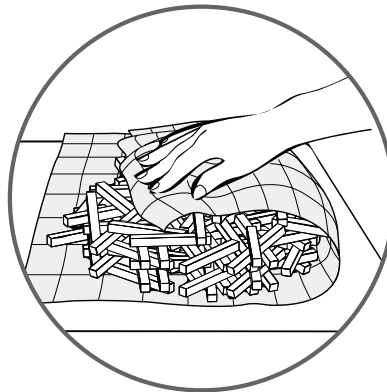
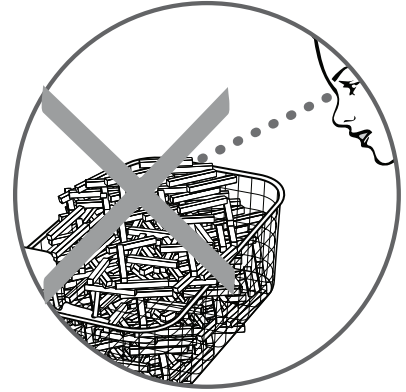
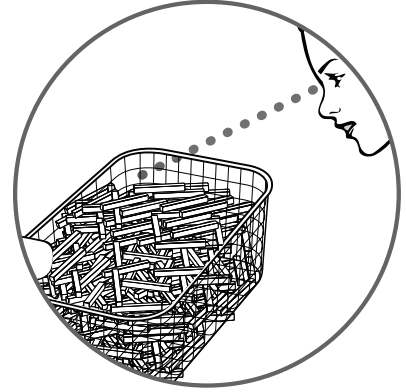
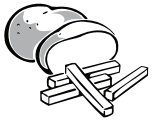
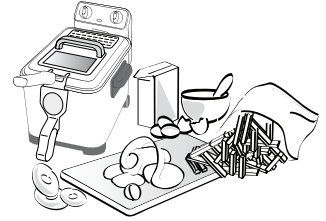

3L - 4L

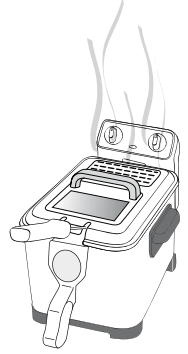

5

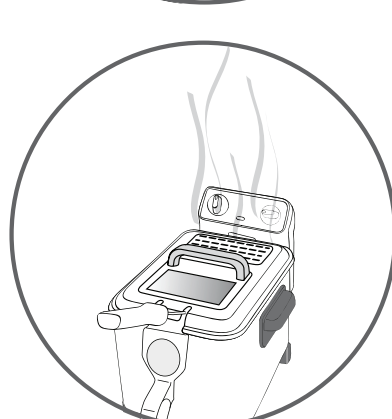
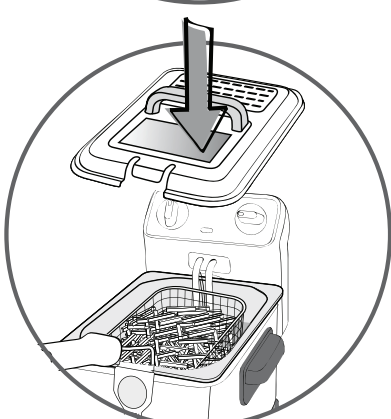
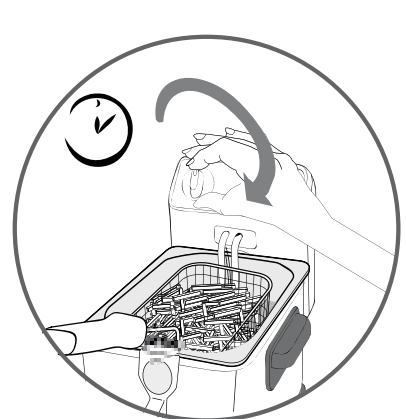
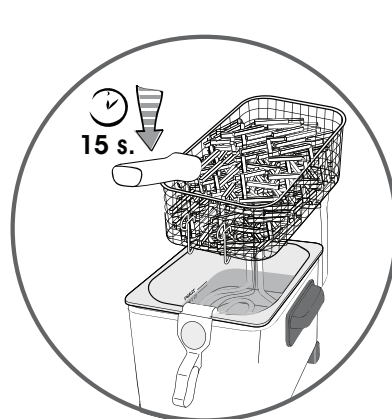
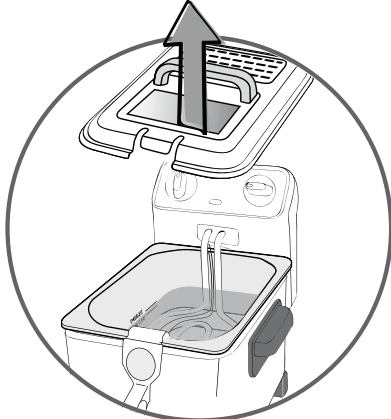
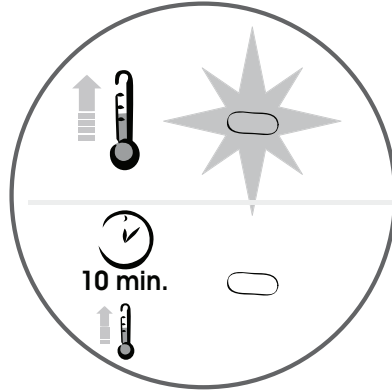
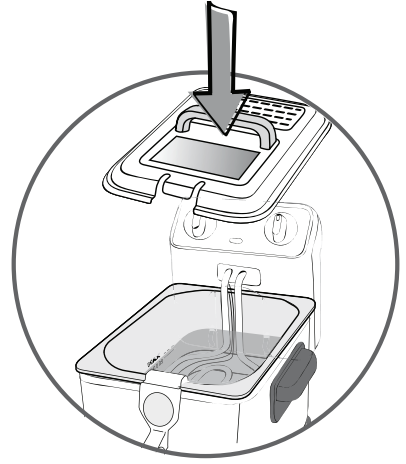
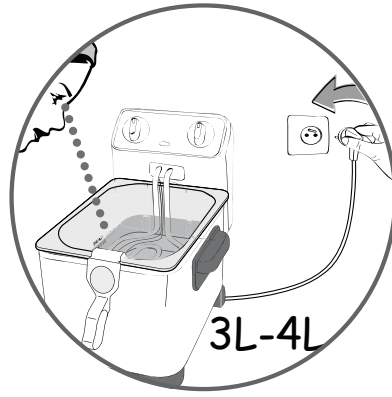

8



6

---

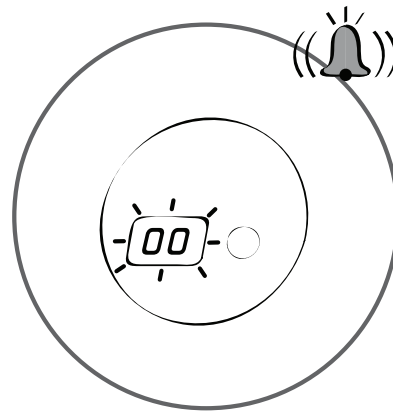
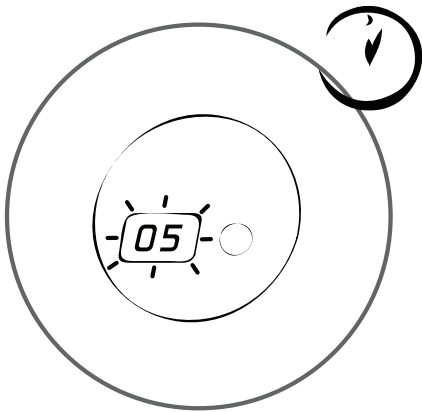
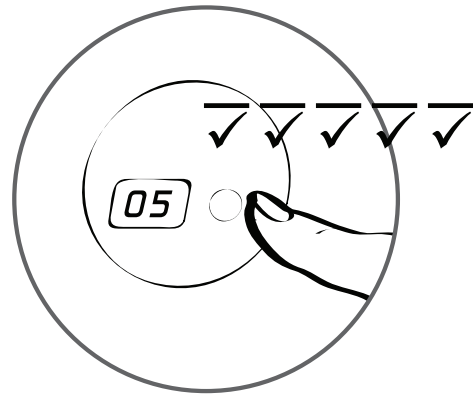
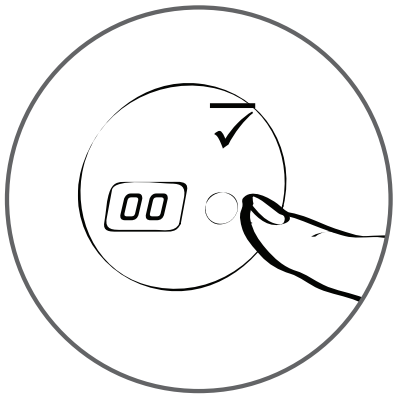

**4L RESET**

7

---

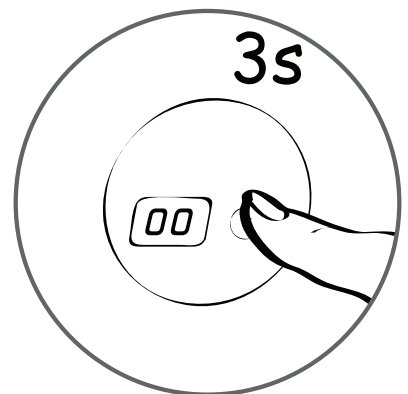
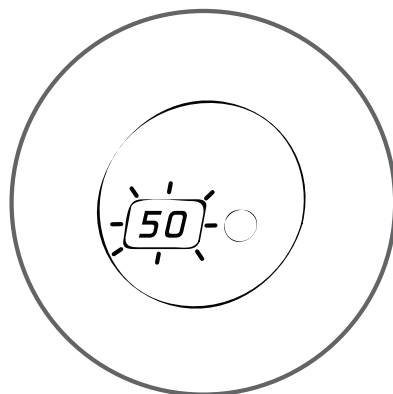
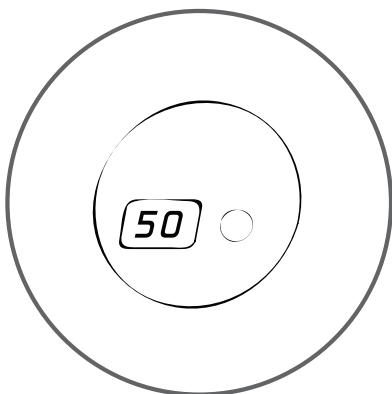

3L

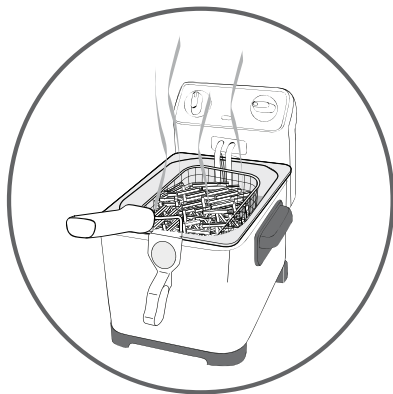
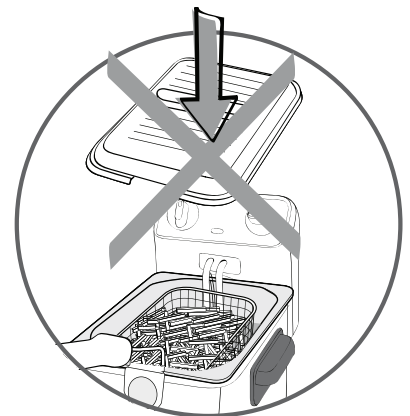
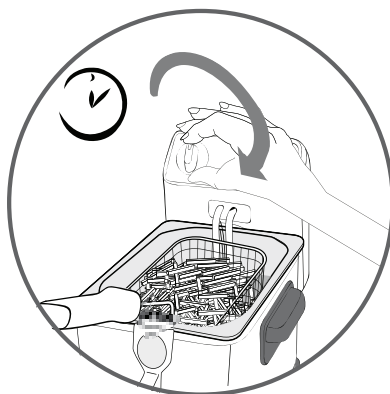
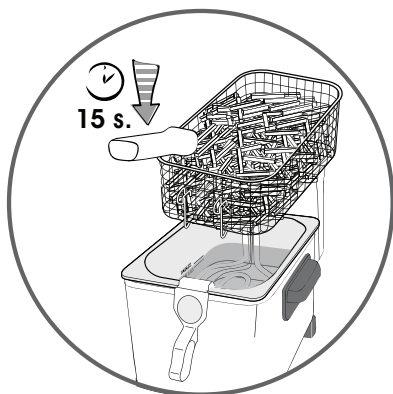
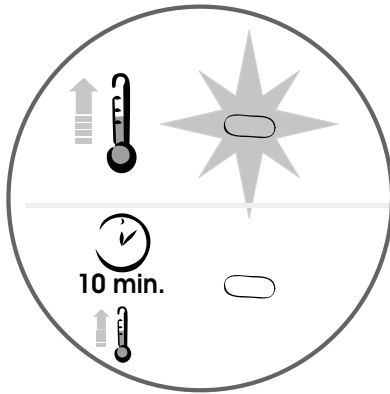
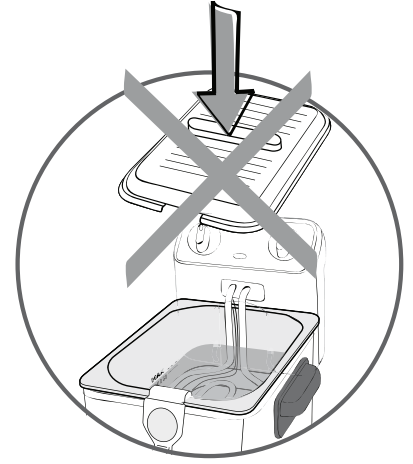
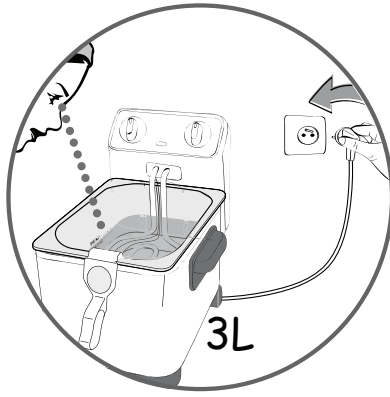
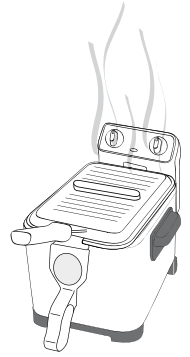

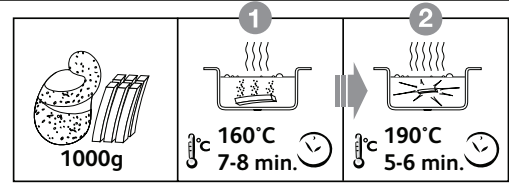

	Nb		°C	
 		1000g	① 160°C	7-8 min.
			② 190°C	5-6 min.
 		600g	170°C	9-10 min.
		800g	180°C	9-10 min.
 		800g	① 160°C	6-7 min.
			② 190°C	3-4 min.
 		400g	170°C	8-9 min.
		700g	180°C	9-10 min.
		400g	160°C	6-8 min.
	8-9		170°C	5-6 min.
<b>* * *</b>			°C	
 		450g	170°C	7-8 min.
		900g	190°C	8-9 min.
 		300g	170°C	6-7 min.
		600g	190°C	7-8 min.
	12		190°C	6-7 min.
 		1300g	190°C	7-8 min.
 		1200g	190°C	7-8 min.
	10-12		190°C	6-8 min.

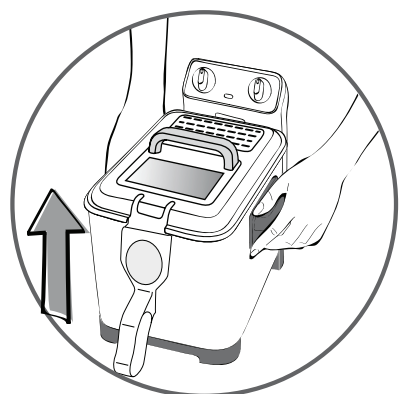
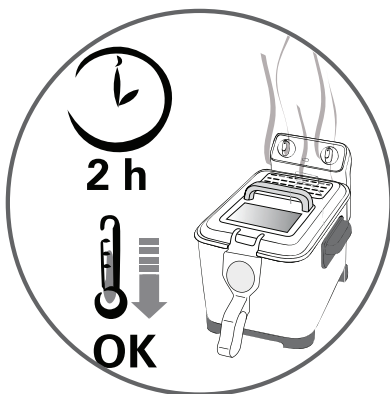
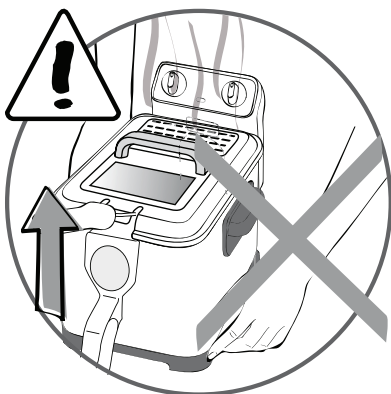
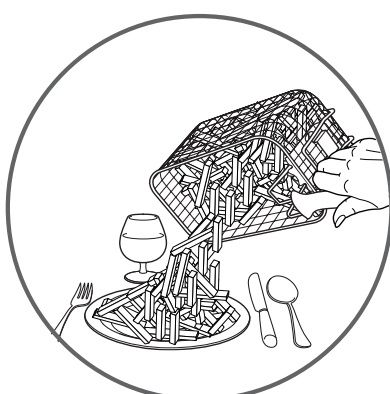
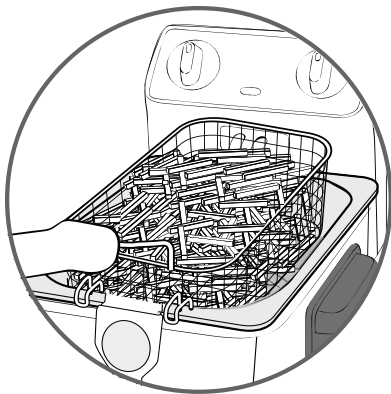
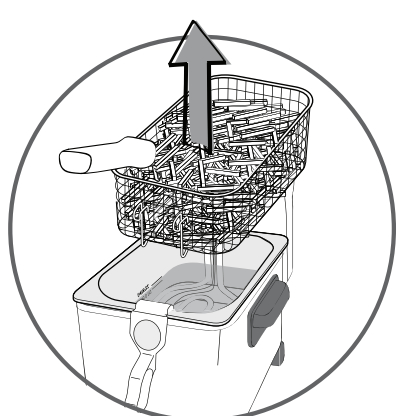
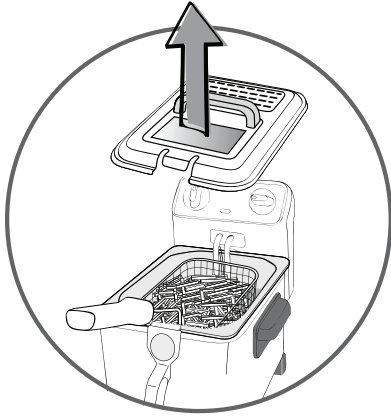
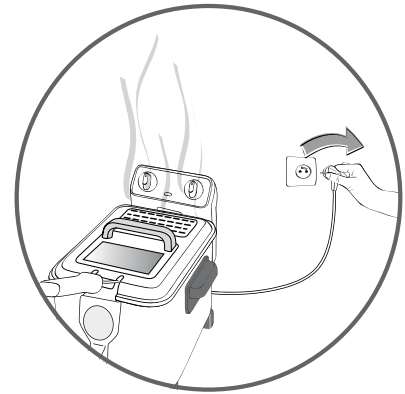
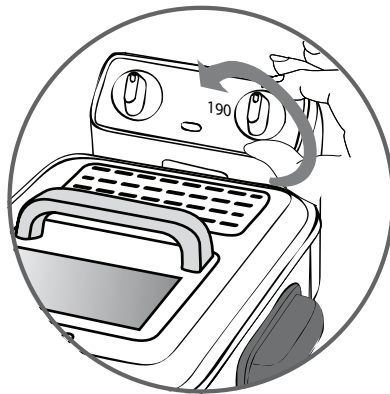
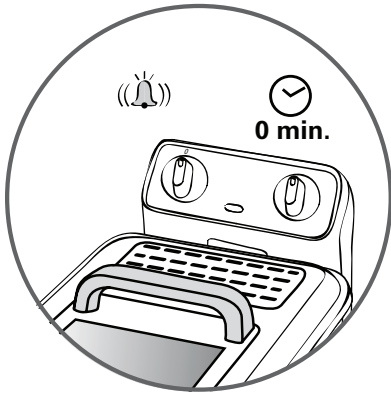

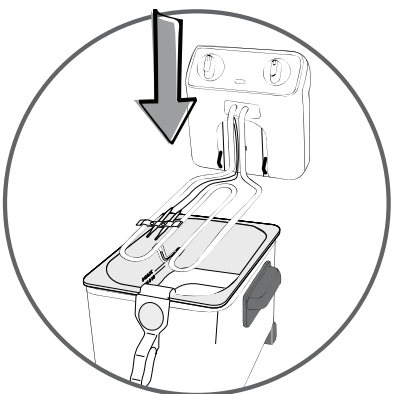
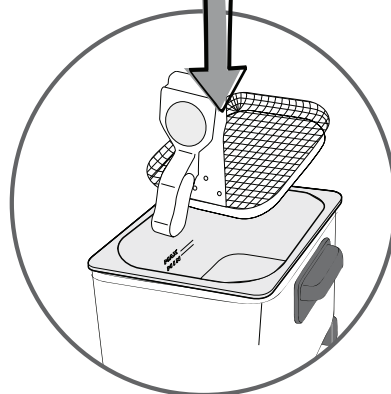
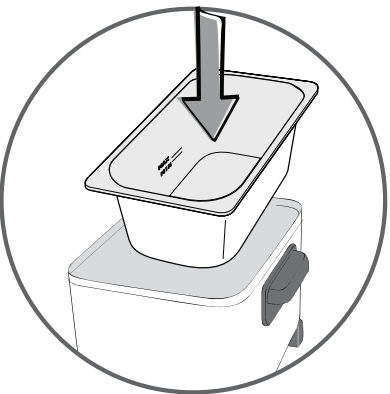
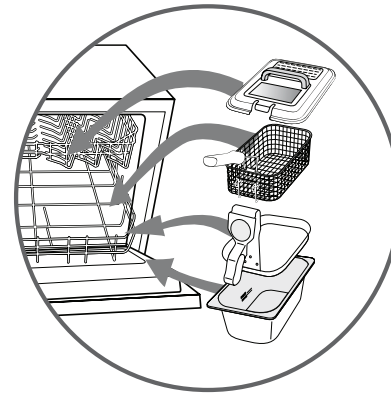
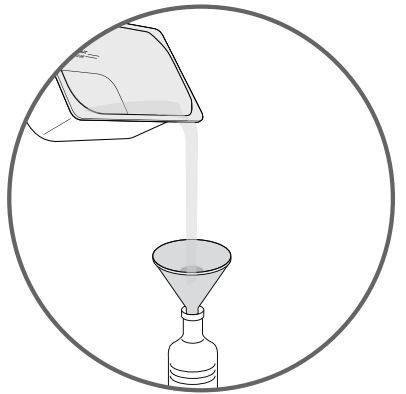
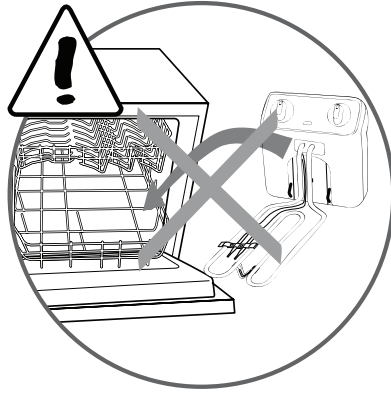
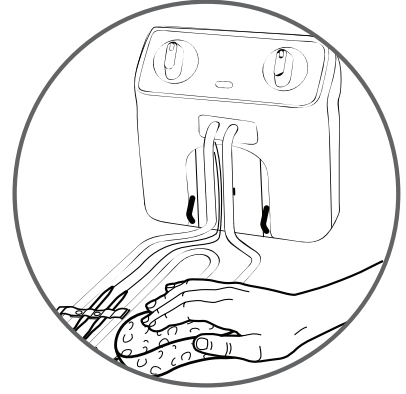
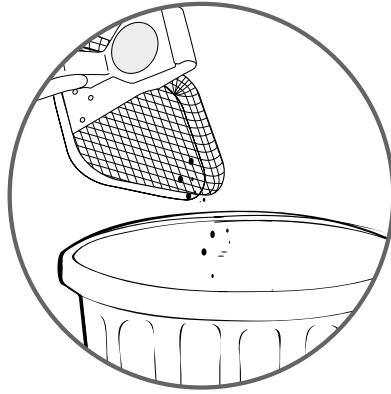
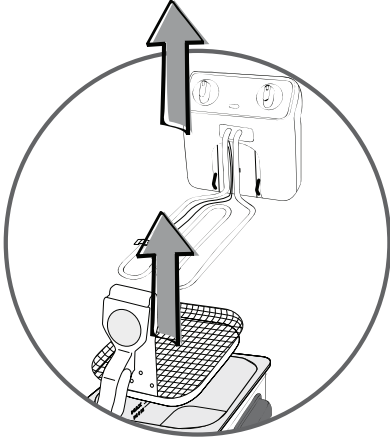
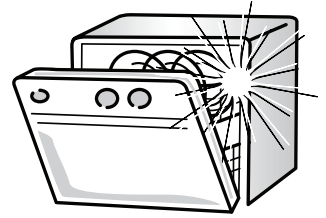

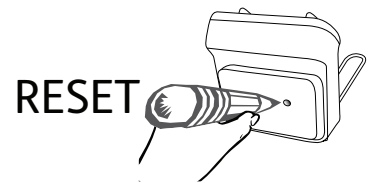
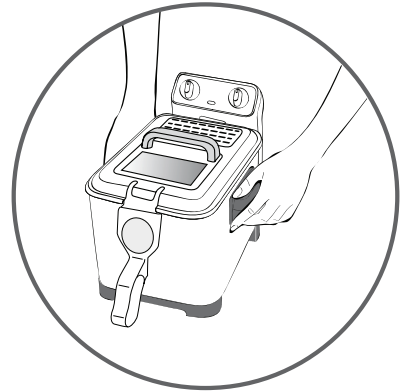
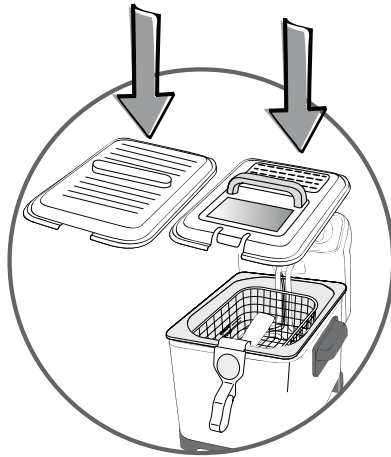
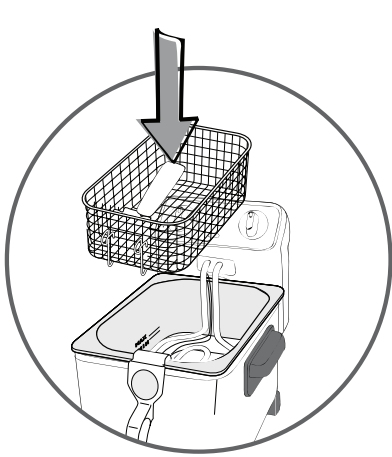

12

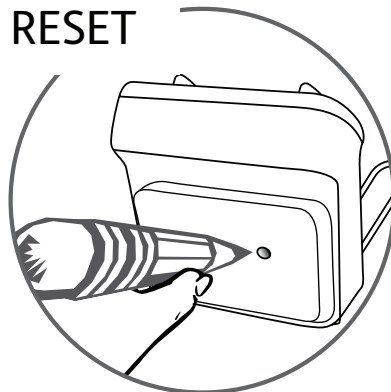
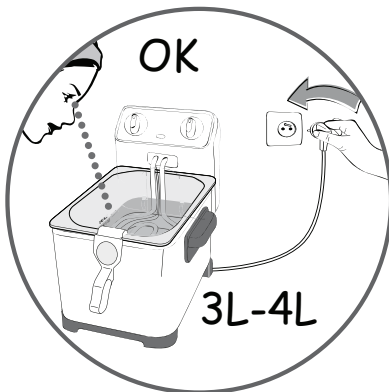
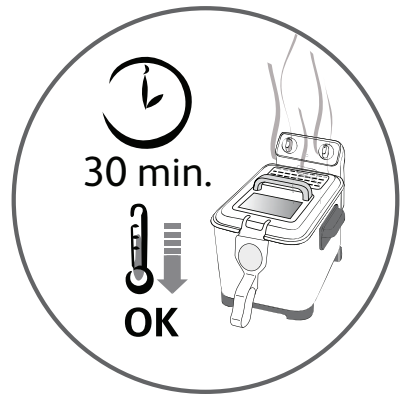
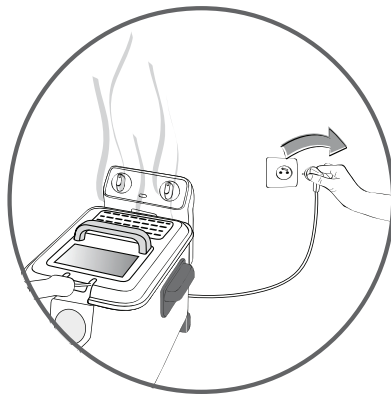
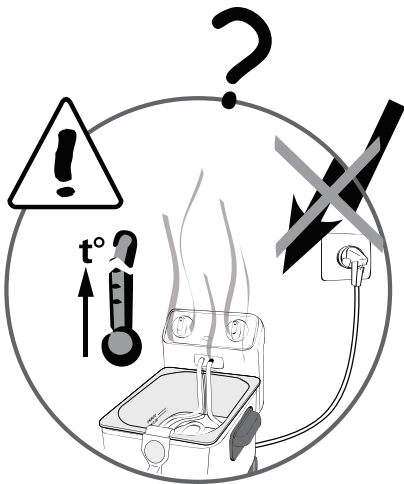

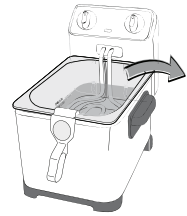

13

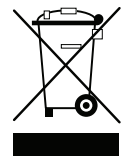
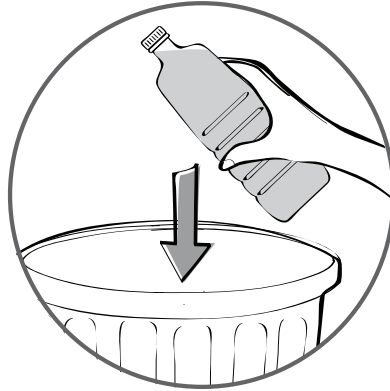
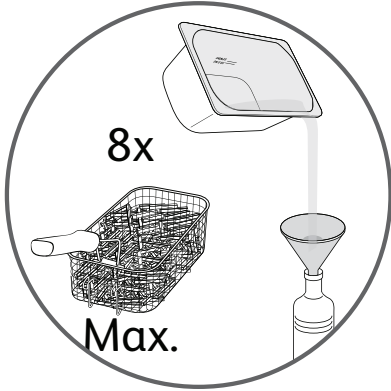

14



