

principio

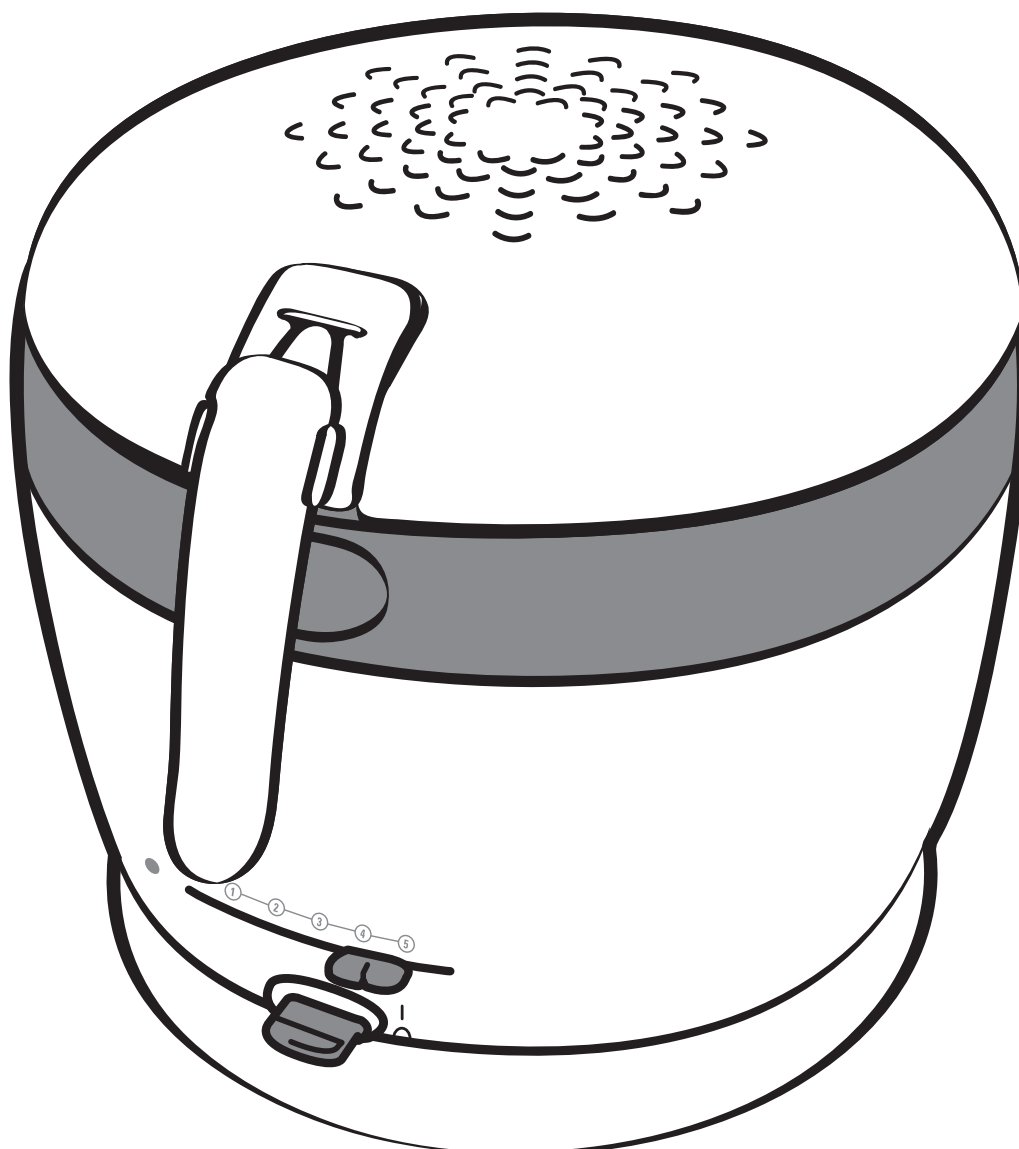

principio

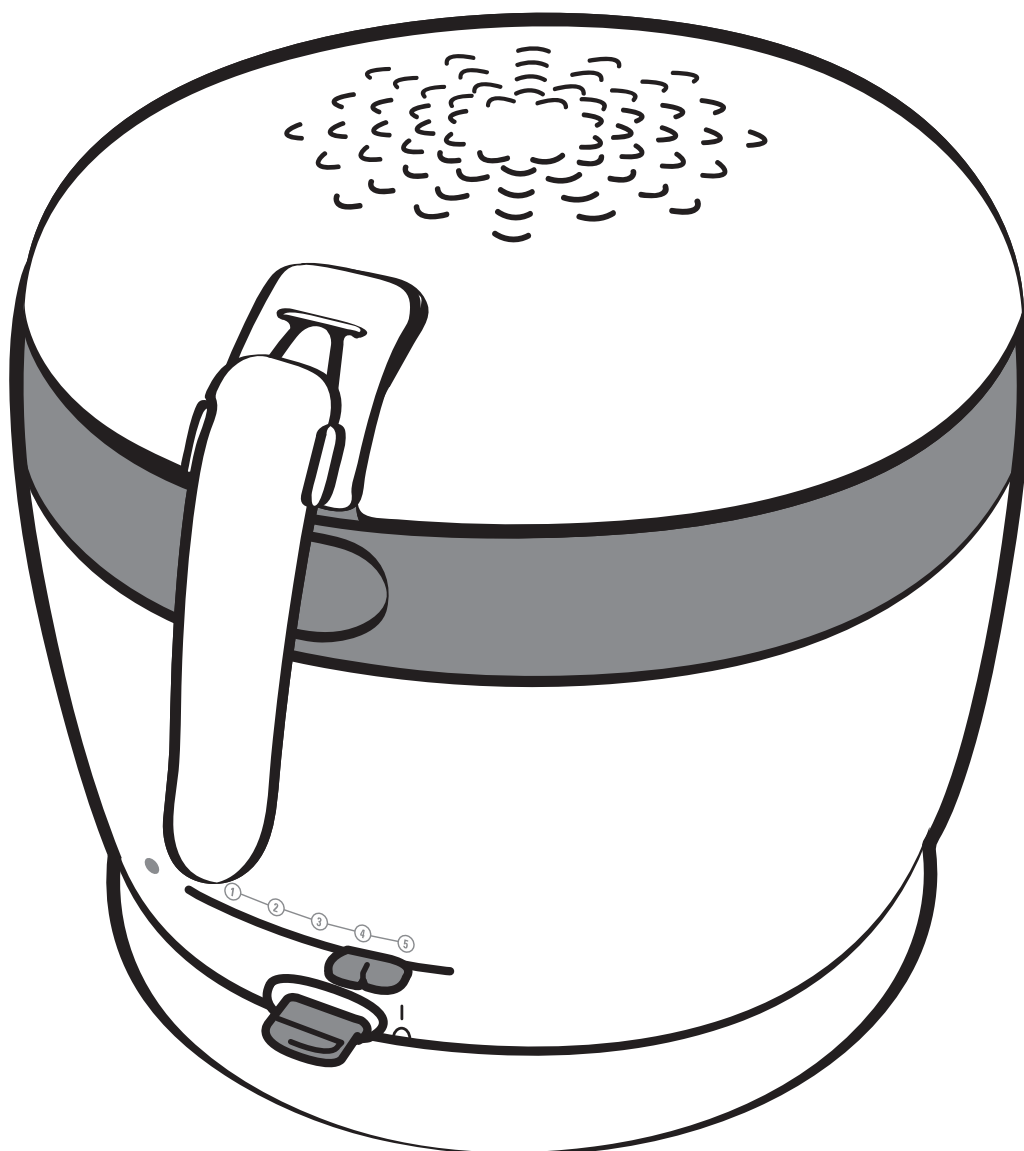

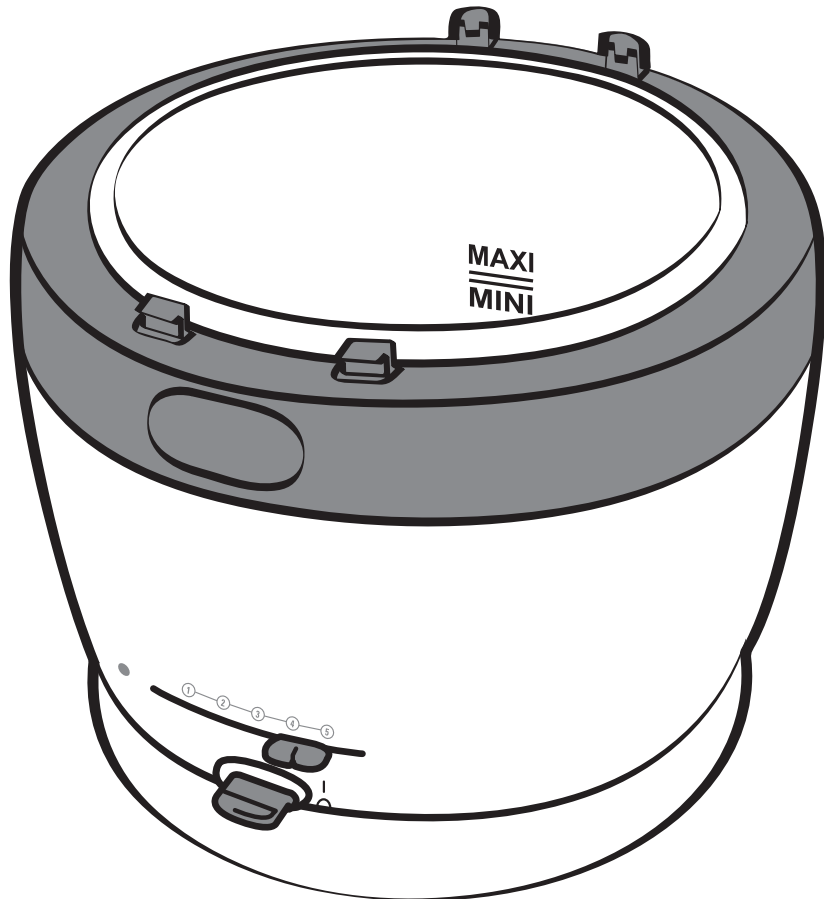
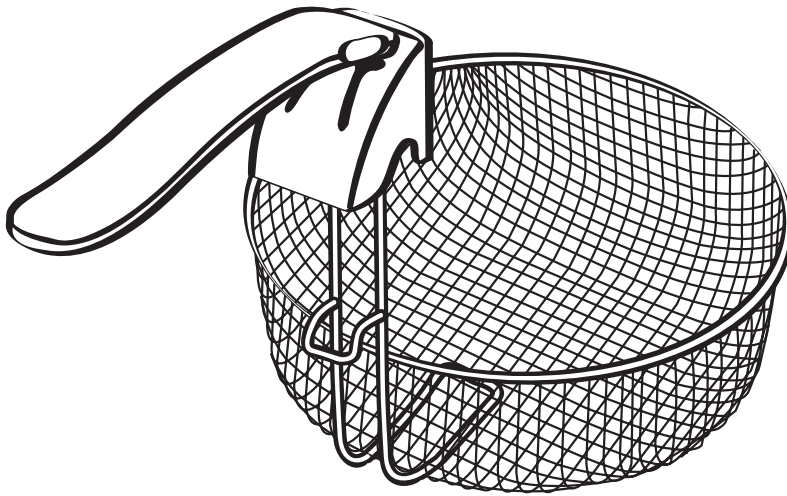
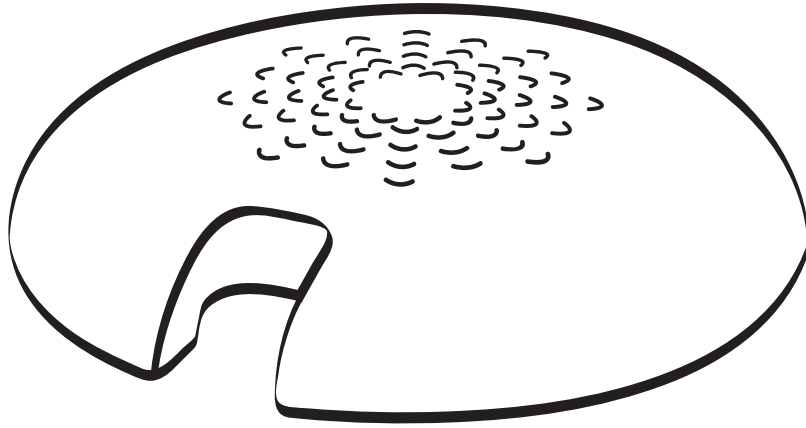

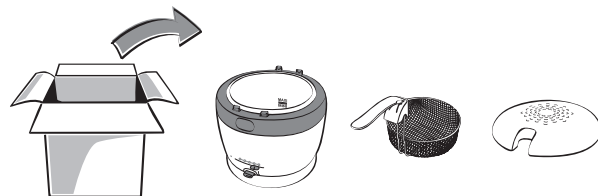

1

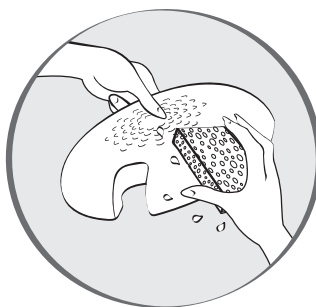
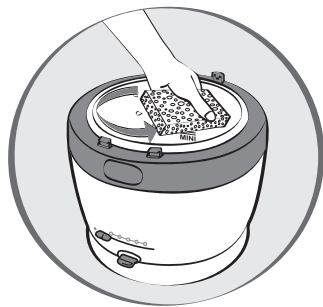
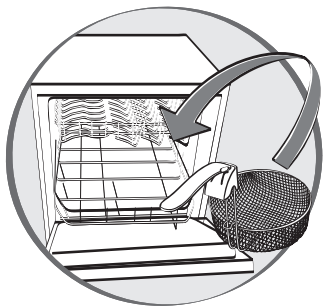
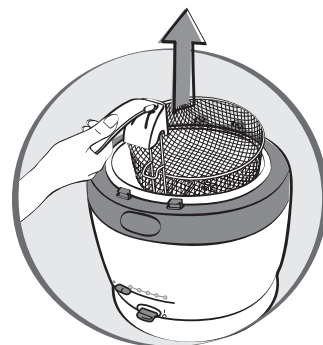
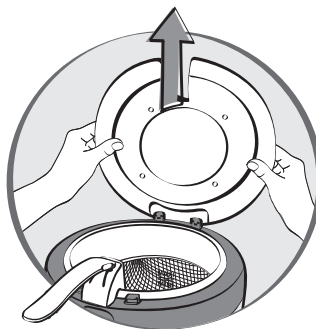
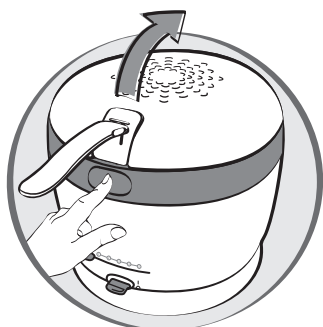
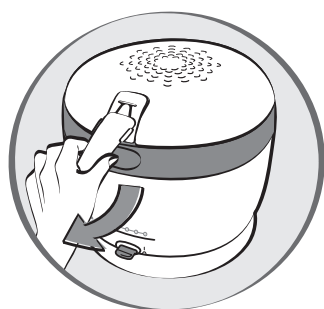

2

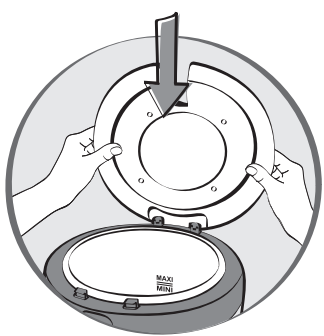

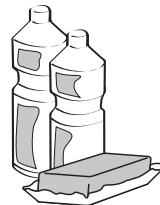

1



Min. 2 L
↓
Max. 2,2 L

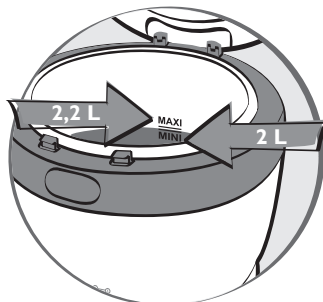
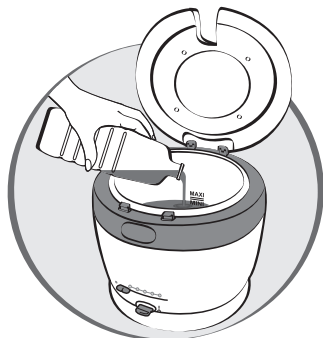

2



Min. 1750 g
↓
Max. 2000 g

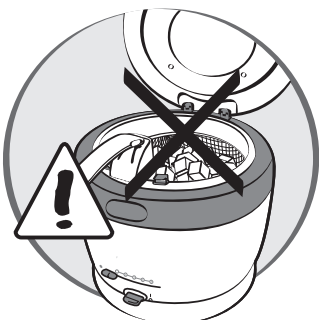
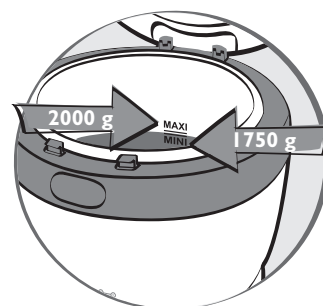
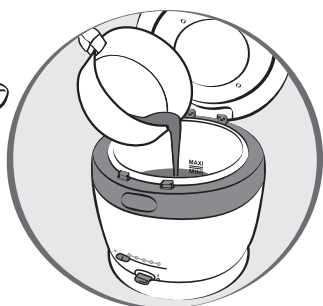



1



Max. 1000 g

500 g

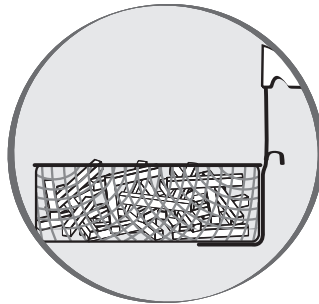

2



Max. 750 g

375 g

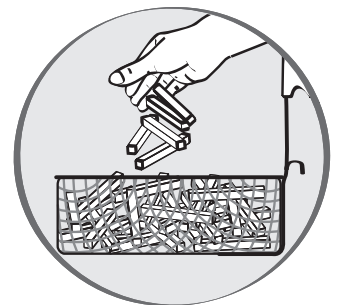
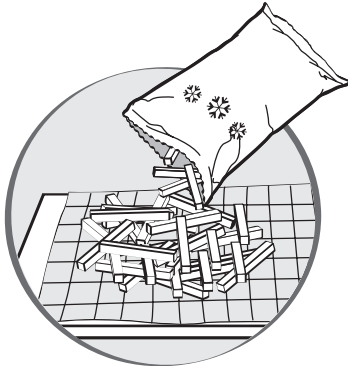

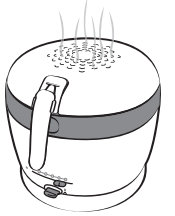

1

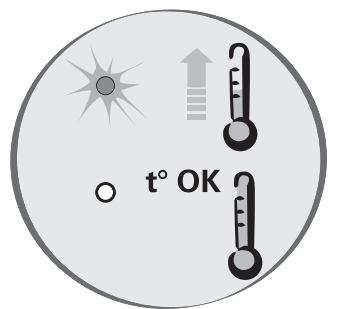
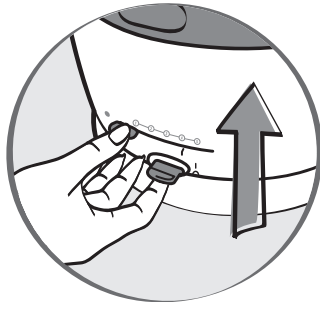
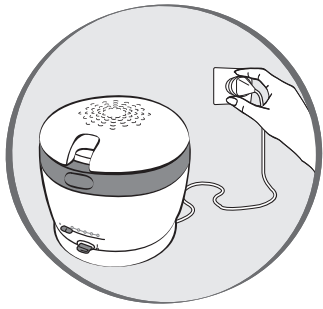

2

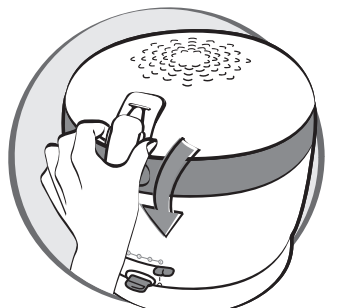
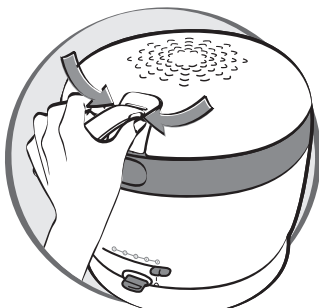
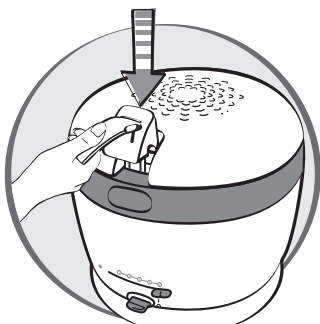
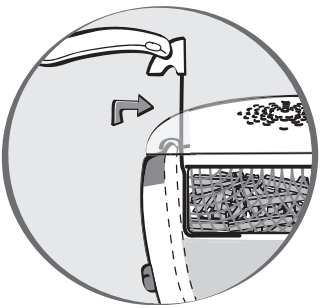
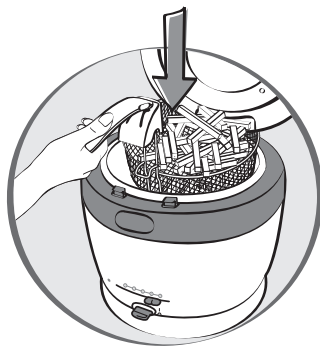

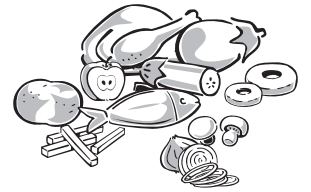

	1000 g	170° C	14 -18 min	-	-
	500 g	170° C	10 -13 min	-	-
	750 g	-	-	170° C	10 -13 min
	375 g	-	-	170° C	7 - 9 min
	3 - 4 p	180° C	14-16 min	190° C	14 -15 min
	1000 g	-	-	190° C	6 - 9 min
	2 p	170° C	6 - 8 min	190° C	6 - 7 min
	8 p	-	-	190° C	5 - 7 min
	8 - 10 p	170° C	5 - 6 min	190° C	4 - 5 min
	8 - 10 p	170° C	5 - 6 min	190° C	4 - 5 min
	6 p	190° C	2 - 3 min	-	-
	8 p	150° C	5 -7 min	150° C	5 -6 min
	4 p	180° C	5 - 6 min	-	-



1

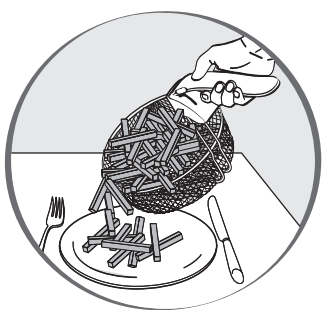
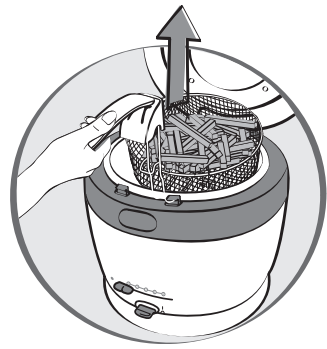
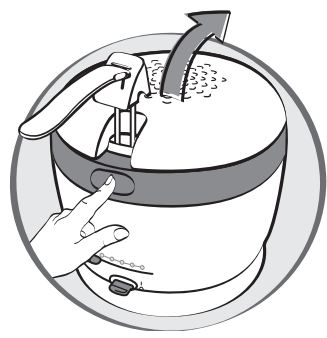
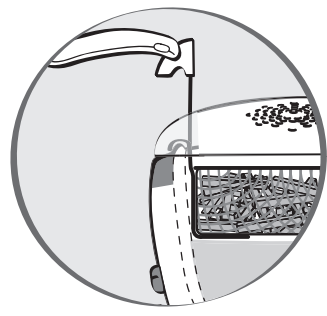
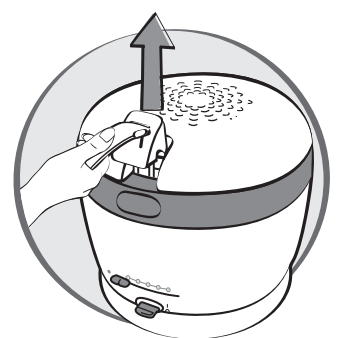
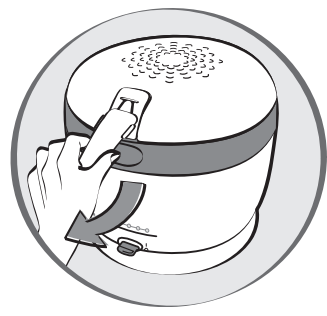
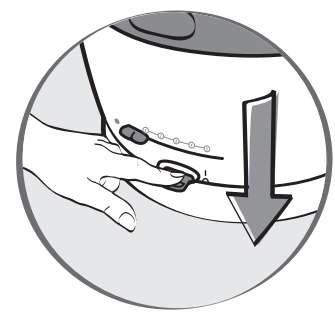

2

